

# EXTRUDER + MIXER | COUNTER TOP MODEL AEX18 CHEFS' FAVORITE

JEMMA

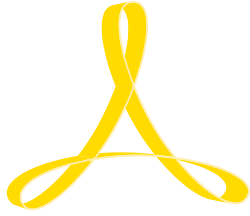

ARCOBALENO®



## STANDARD FEATURES

- Mixer and extruder— all-in-one process
- Best ROI for your kitchen
- Over 150 dies to choose from
- Includes automatic cutting knife for short pastas
- Industrial, high-torque motor
- Stainless steel hopper
- Removable stainless steel mixer shaft & auger for easy cleaning
- Crumbly dough mixture is extruded through a solid brass die to create over 150 possible pasta shapes
- Portable, compact & versatile machine is easy-to-use
- 120 Volts
- Factory and on-location training. The Only Full-Service Pasta Machine Manufacturer in North America!

## OPTIONAL FEATURES & ACCESSORIES

- Pasta trays - Perforated - Dim: 15.5"W x 23.5"D x 2.75"H
- Pasta trays - Solid - Dim: 15.5"W x 23.5"D x 2.75"H
- APC8 Mobile pasta cart with 8 trays
- APC20 Mobile pasta cart with 20 trays
- Lasagna sheet die with 6.25" dough sheet width and Adjustable Thickness: 1/32" - 3/16"
- Rolling pin for lasagna sheet die
- Extruder dies with Teflon inserts



Optional  
APC8 Pasta Cart



CUTTING KNIFE  
FOR SHORT PASTAS



LASAGNA  
SHEET DIE  
(#60s)

©2023 Arcobaleno®, LLC

CAD file available. Please contact factory 717-394-1402.

160 GREENFIELD ROAD | LANCASTER, PA 17601  
ARCOBALENOPASTA.COM | 717.394.1402

  
@ARCOBALENOPASTA



# EXTRUDER & MIXER | COUNTER TOP MODEL AEX18

ARCOBALENO®

## TECHNICAL SPECIFICATIONS

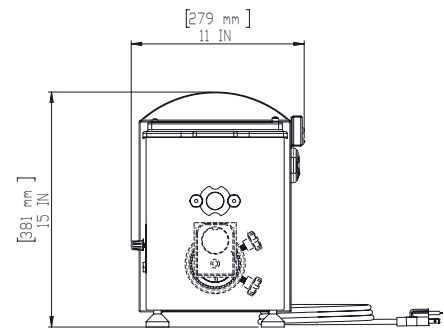
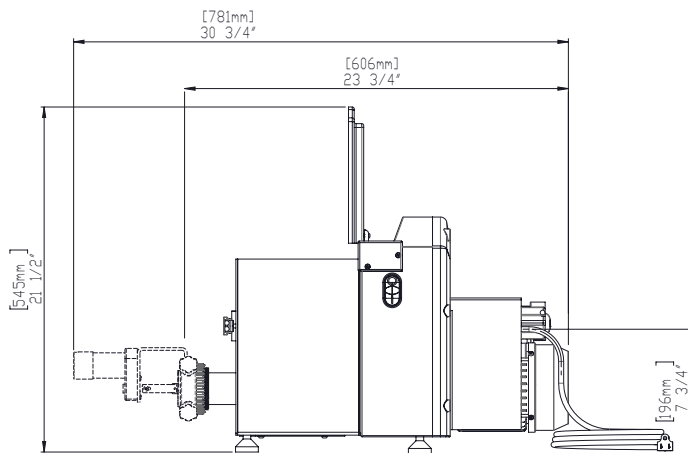

Model	AEX18
Hourly Production*	Up to 15-20 lbs/hr *Production varies by pasta shape
Mixer Capacity (flour)	2,000 g (4.25 lbs)
Mixer Production (flour + liquid)	2,600 g/batch (5.5 lbs/batch)
Electrical Power	120V 60Hz 0.5HP (6 Amps)
Nema Plug	5-15
Cord Length	5 ft
Machine Dimensions	11"W x 30.75"D x 15"H (with knife)
Shipping Dimensions	14.50"W x 28.5"D x 23"H
Machine Weight	75 lbs
Shipping Weight	95 lbs
Shipping Class	85



## PAYS FOR ITSELF IN 30 DAYS!

### AEX18 ROI BREAKDOWN

#### Semolina Flour Cost

**50 LB BAG OF SEMOLINA FLOUR = \$40**
**YIELDS 65 LBS OF FRESH PASTA**
**MAKES 130 - 8 OZ SERVINGS**

ONLY **\$0.31** PER 8 OZ SERVING!

#### AEX18 Production



**AEX18 PRODUCES 5.5 LBS (88 OZ) PER BATCH**
**MAKES 11 8 OZ SERVINGS PER BATCH**

#### Pay Off - 30 Days

**\$15-18**

AVERAGE COST OF 8 OZ PASTA DISH

**18**

18 PASTA DISHES SOLD PER DAY = \$270-324

ROI calculations are examples for illustrative purposes only and actual costs may vary therefore; Arcobaleno, LLC cannot promise or guarantee the ROI benefits.

## FLOUR+WATER RECIPE FOR AEX18

### (30% Hydration)

2,000 grams of flour  
600 grams of cold water

*Note: This may vary upon kitchen humidity & environment. Please adjust accordingly.*

## WHOLE EGG RECIPE FOR AEX18

### (35% Hydration)

2,000 grams of flour  
4 whole eggs (Approximately 50 grams per egg)\*  
500 grams of cold water

\* Egg size may vary. Please adjust accordingly.

## DIRECTIONS FOR AEX18 RECIPES:

Weigh out flour and liquid required for the batch. If applicable, mix cold water and eggs together with whisk. Put flour in hopper and turn on mix mode, slowly add liquid, moving the container back and forth along the opening. Mix for 4 minutes. Check consistency of contents, dough should start to clump and form a coarse crumbly flour texture. The consistency of the egg pasta dough should look like small pebble sized dough balls. Set machine to extrude mode, begin to extrude. Never extrude dry flour.

**RECIPE!**

# EXTRUDED PASTA SHAPES

## FOR MODELS AEX18 JEMMA



= New Dies













= Favorite Dies

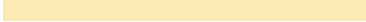

= Hand Cut Only

Sizes measured from pasta dies, pasta size may vary slightly

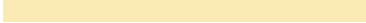
### SPAGHETTI

-  ● #7 1.5 mm
-  ● #8 1.7 mm 
-  ● #9 1.9 mm
-  ● #10 2.1 mm 
-  ● #11 2.3 mm
-  ● #12 2.5 mm
-  ▲ #410 3 mm 





### BIGOLI

-  ● #13 3 mm
-  ● #14 3.5 mm 
-  ● #15 4 mm

### LINGUINE

-  ● #21 3 x 1.6 mm
-  ● #21A 3.5 x 1.6 mm
-  ● #22 4 x 1.6 mm 

### SPAGHETTI/ALLA CHITARRA/ TONARELLI

-  ■ #23 1.5 mm
-  ■ #24 2 mm 
-  ■ #26 2.5 mm
-  ■ #27 3 mm



Teflon dies are available for smooth texture and used for Gluten Free and Non Traditional Recipes. Our #23 Teflon and #24 Teflon dies can be used to make ramen. *Call for more information!*







#410 Triangle Spaghetti



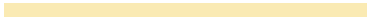
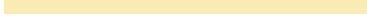



#414 Pizzoccheri









### TAGLIATELLE

-  ■ #30 1.8 mm
-  ■ #31 2.5 mm
-  ■ #32 3.5 mm
-  ■ #33 4.5 mm
-  ■ #34 6 mm 

### FETTUCCINE

-  ■ #35 8 mm 
-  ■ #36 10 mm
-  ■ #414 Pizzoccheri  8 x 1.8 mm

### PAPPARDELLE

-  ■ #37 12 mm
-  ■ #38 15 mm 
-  ■ #38/02 17 mm
-  ■ #39 20 mm 
-  ■ #40 25 mm (1 inch) 
-  ■ #263 17 mm Sagnarelli [with ridges]

# EXTRUDED PASTA SHAPES

FOR MODELS AEX18 JEMMA

## MAFALDE



## BUCATINI/PERCIATELLI



## ZITI/PACCHERI

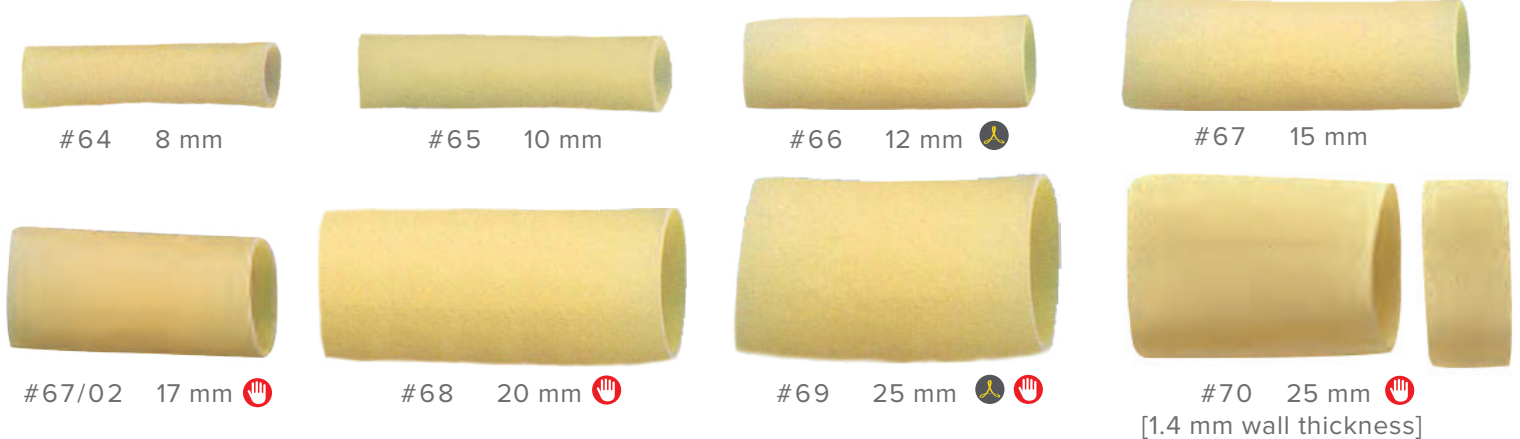

## MM to INCHES Conversion Chart



Dime = 17mm (11/16")



Penny = 19mm (3/4")



Nickel = 21mm (7/8")



Quarter = 24mm (15/16")

MM	Approx. Size in Inches
1mm	1/32"
2mm	1/16"
3mm	3/32"
4mm	1/8"
5mm	3/16"
6mm	slightly less than 1/4"
7mm	slightly more than 1/4"
8mm	5/16"
9mm	slightly less than 3/8"
10mm	slightly more than 3/8"
11mm	7/16"
12mm	slightly less than 1/2"
13mm	slightly more than 1/2"
14mm	9/16"
15mm	slightly less than 5/8"
16mm	5/8"
17mm	slightly less than 11/16"
18mm	slightly less than 3/4"
19mm	slightly more than 3/4"
20mm	slightly less than 13/16"
21mm	slightly more than 13/16"
22mm	slightly less than 7/8"
23mm	slightly more than 7/8"
24mm	15/16"
25mm	about 1"
26mm	about 1 1/32"
27mm	about 1 1/16"
28mm	about 1 1/8"
29mm	about 1 5/32"
30mm	about 1 3/16"
31mm	about 1 7/32"
32mm	slightly more than 1 1/4"
33mm	about 1 5/16"
34mm	about 1 1/32"

# EXTRUDED PASTA SHAPES

## FOR MODELS AEX18 JEMMA



= New Dies



= Favorite Dies



= Hand Cut Only

Sizes measured from pasta dies, pasta size may vary slightly

### RIGATONI



#73 12 mm



#73/02 13 mm



#73/04 11 mm



#76 6 mm  
[with ridges]



#77 8 mm  
[with ridges]



#78 10 mm   
[with ridges]



#79 12 mm   
[with ridges]



#80 15 mm   
[with ridges]



#81 20 mm   
[with ridges]

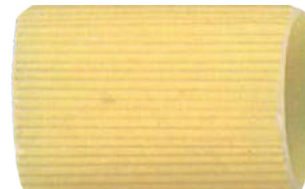

#82 25 mm   
[with ridges]



#83 26.5 mm   
[1.4 mm wall thickness]  
[with ridges]



#84 23 mm   
[1.3 mm wall thickness]  
[with ridges]



#85 10.5 mm  
[1.05 mm wall thickness]  
[with ridges]



#86 13.5 mm   
[1.2 mm wall thickness]  
[with ridges]



#87 17.5 mm   
[1.2 mm wall thickness]  
[with ridges]



#386 10 mm  
Trenne  
[with ridges]



#386/15L   
Trenne



#386/15R   
Trenne  
[with ridges]



#264 11.4 mm  
Smooth Trenne



#392 10mm  
Square Rigatoni  
[with ridges]



#392/15L   
Square Rigatoni



#392/15R   
Square Rigatoni  
[with ridges]



#533L   
Heart-atonì



#533RO   
Heart-atonì  
[with ridges]



# EXTRUDED PASTA SHAPES FOR MODELS AEX18 JEMMA

 = New Dies

 = Favorite Dies

 = Hand Cut Only

Sizes measured from pasta dies, pasta size may vary slightly

## ELICOIDALI

Reversed Ridges





#110 6 mm  
[with ridges]



#112 9.5 mm  
[with ridges]



#416 18 mm    
[with ridges]



## GRAMIGNE



#91 3 mm



#92 4 mm 



#93 3.8 mm  
[with ridges]

## CANESTRI/LUMACHE [SMOOTH]



#94  
7.8 mm



#95  
9.8 mm



#96  
12.5 mm



#97  
15 mm

## CANESTRI/LUMACHE [WITH RIDGES]



#99 8.6 mm



#100 10.5 mm



#101 13.5 mm 



#102 16 mm



#438 26 mm 

## MACARONI [SMOOTH]



#120  
3.2 mm



#121  
4.2 mm



#122  
6 mm



#123  
7.8 mm



#124   
9.8 mm



#125  
12.5 mm



#126  
15 mm

## MACARONI [WITH RIDGES]



#133  
10.5 mm



#134  
13.5 mm





### DID YOU KNOW?

Teflon dies are available for smooth texture and used for Gluten Free and Non Traditional Recipes. Call for more information!

# EXTRUDED PASTA SHAPES

## FOR MODELS AEX18 JEMMA

 = New Dies    = Favorite Dies    = Hand Cut Only  
*Sizes measured from pasta dies, pasta size may vary slightly*

### CRESTE DE GALLO



### SHELLS [SMOOTH]



### SHELLS [WITH RIDGES]



### ORECCHIETTE



### GNOCCHI SARDI

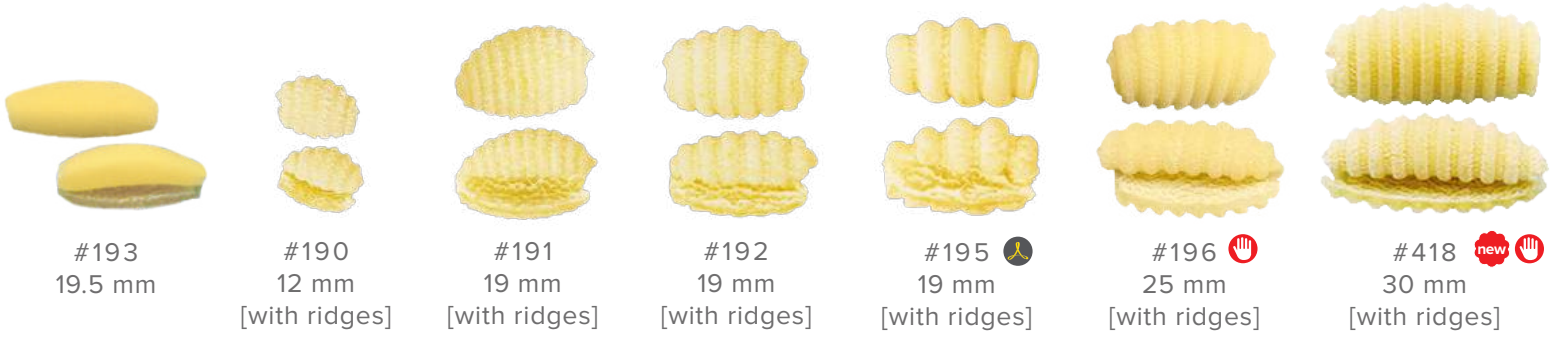

### CLAM SHELLS [SMOOTH]

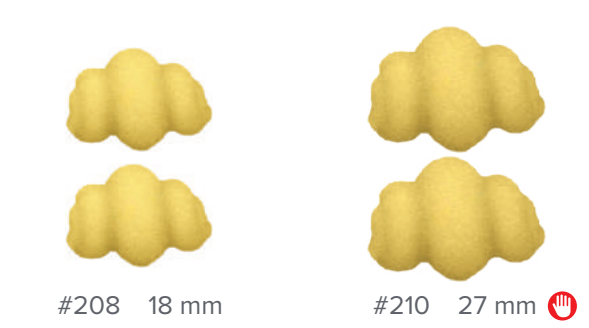

### CLAM SHELLS [WITH RIDGES]

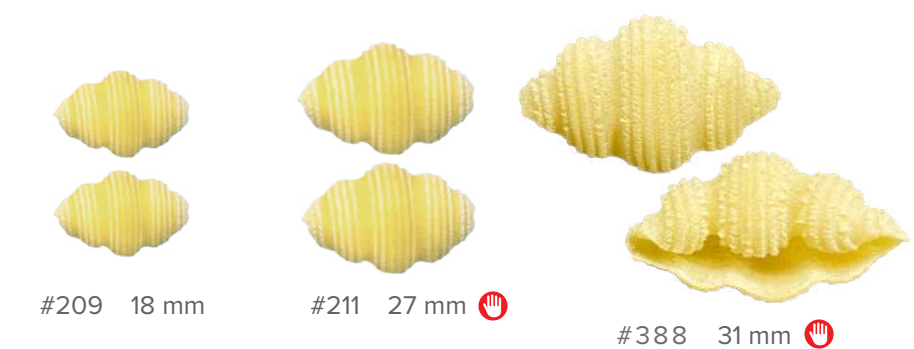

# EXTRUDED PASTA SHAPES

## FOR MODELS AEX18 JEMMA



= New Dies



= Favorite Dies



= Hand Cut Only

Sizes measured from pasta dies, pasta size may vary slightly

### GEMELLI

### CASARECCE

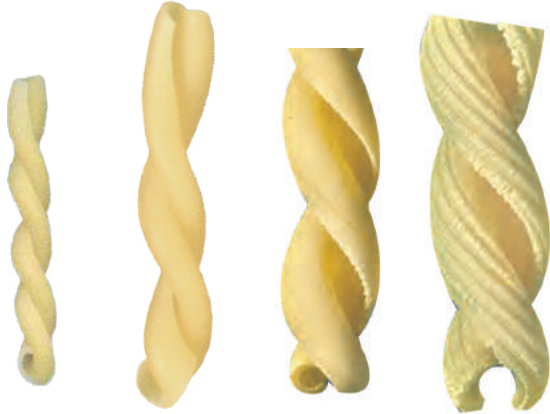

#214 6.4 mm  
#215 8.8 mm  
#216 14.2 mm  
#225 14.2 mm [with ridges]



#219 7.8 mm  
#220 8.8 mm  
#221 12 mm  
#227 12 mm [with ridges]  
#368 10.5 mm [with ridges]  
#420 6.5 mm [new]

### FUSILLI

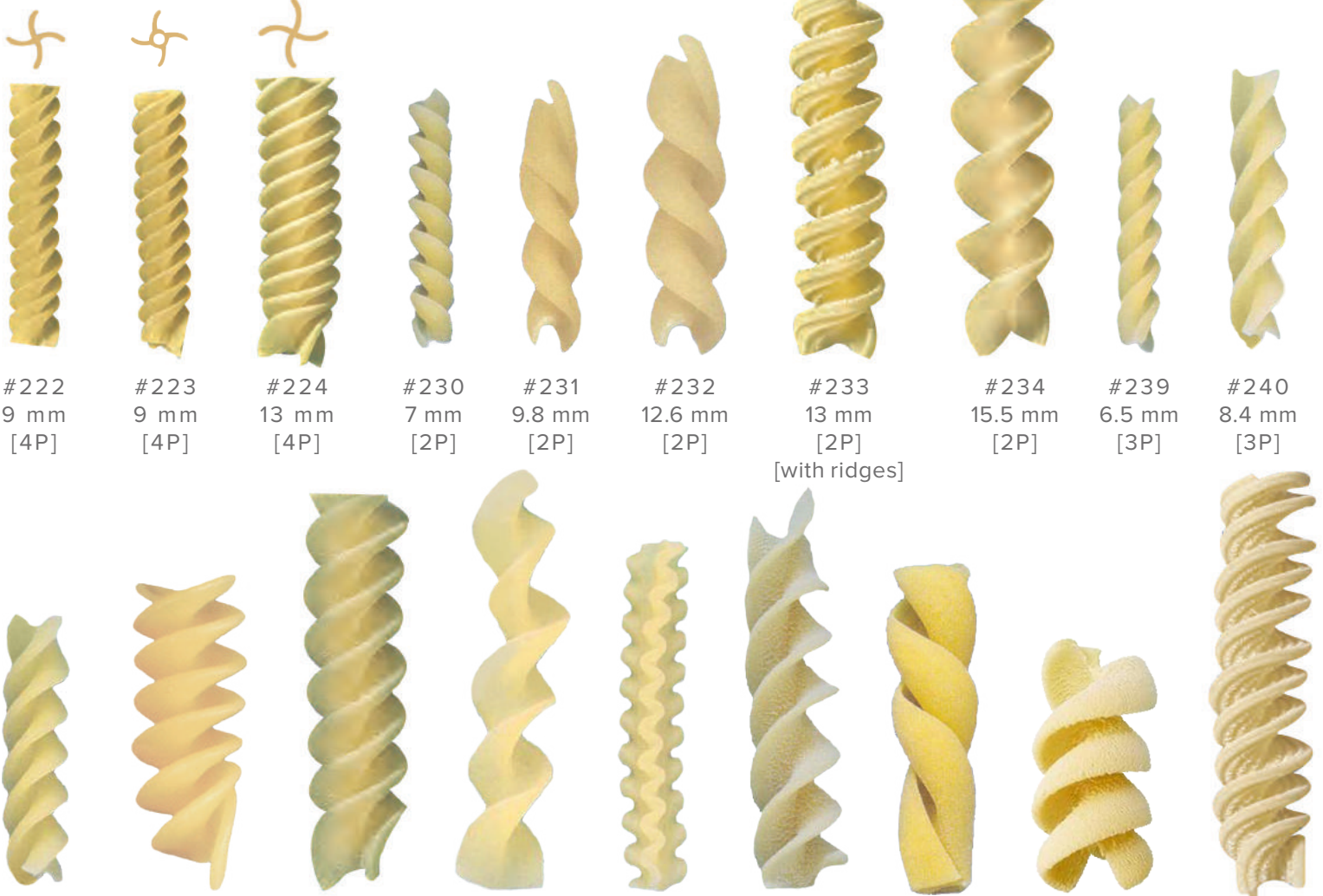

#222 9 mm [4P]  
#223 9 mm [4P]  
#224 13 mm [4P]  
#230 7 mm [2P]  
#231 9.8 mm [2P]  
#232 12.6 mm [2P]  
#233 13 mm [2P] [with ridges]  
#234 15.5 mm [2P]  
#239 6.5 mm [3P]  
#240 8.4 mm [3P]  
#241 10 mm [3P]  
#242 15.5 mm [2P]  
#243 13 mm [3P]  
#244 12.6 mm [2P]  
#246 10.5 mm [3P]  
#366 13 mm [3P]  
#380 17.4 mm [2P]  
#406 20 mm [2P] [new]  
#454 13 mm [3P] [with ridges]



# EXTRUDED PASTA SHAPES

## FOR MODELS AEX18 JEMMA

 = New Dies    = Favorite Dies    = Hand Cut Only

Sizes measured from pasta dies, pasta size may vary slightly

### SHAPES ON SHAPES ON SHAPES

 <p>#251 10.4 mm Trottole</p>	   <p>#249 11.4 mm Campanelle [with ridges]</p> <p>#252 11.4 mm </p>	 <p>#253 28 mm  </p> <p>Londa</p>	 <p>#404 16.5 mm  </p> <p>Londa</p>	
 <p>#254 11 mm Torchietti [with ridges]</p>	 <p>#256 18 mm </p>	 <p>#258 12.5 mm Specialty 3-Loop</p>	 <p>#260 17.5 mm </p> <p>Radiatori</p>	 <p>#261 25 mm </p> <p>Radiatori</p>
 <p>#262A 13.5 mm </p> <p>Anellini</p>	 <p>#262B 19 mm  </p> <p>Bumbola</p>	 <p>#263 17 mm Sagnarelli [with ridges]</p>		
 <p>#264 11.4 mm Smooth Trenne</p>	 <p>#386 10 mm Trenne [with ridges]</p>	 <p>#386/15L </p> <p>Trenne</p>	 <p>#386/15R </p> <p>Trenne [with ridges]</p>	 <p>#392 10mm Square Rigatoni [with ridges]</p>
 <p>#392/15L </p> <p>Square Rigatoni</p>	 <p>#392/15R </p> <p>Square Rigatoni [with ridges]</p>	 <p>#533L </p> <p>Heart-atoni</p>	 <p>#533RO </p> <p>Heart-atoni [with ridges]</p>	 <p>#270 16.5 mm </p> <p>Rotelle (Wagon Wheel)</p>

# EXTRUDED PASTA SHAPES

## FOR MODELS AEX18 JEMMA

 = New Dies

 = Favorite Dies

 = Hand Cut Only

Sizes measured from pasta dies, pasta size may vary slightly



#267 8.3 mm   
Garganelli  
[with ridges]



#268 6.6 mm  
Messinesi



#425 5.8 mm   
Calabreselli



#273 6.5 mm  
Torchietto  
[with ridges]



#274 14 mm   
Creste di Bruco



#362 10 mm   
Rustic Torchio  
[with ridges]





#369 25 mm   
Calamarata



#370 18 mm  
Girelle



#275 14 mm    
Mafalde Bucatini





#368 10.5 mm   
Rustic Casarecce  
[with ridges]



#366 13 mm  
Large Rustic Fusilloni  
[3P]



#406 20 mm    
Fusilloni  
[2P]





#454 13 mm  
Fusilloni  
[3P]  
[with ridges]

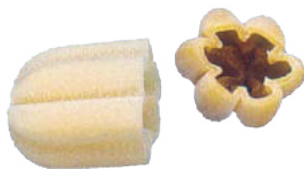

#372 8.8 mm  
Maccheroncelli



#374 22.5 mm    
Zucca



#408 17 mm   
Zucca



#378 11.8 mm  
Stella

# EXTRUDED PASTA SHAPES FOR MODELS AEX18 JEMMA

 = New Dies  = Favorite Dies  = Hand Cut Only

Sizes measured from pasta dies, pasta size may vary slightly



#380 17.4 mm  
Treccioni  
[2P]



#384 25 mm   
Caramelle



#388 31 mm   
Clam Shell  
[with ridges]



#398 15 mm   
Fiori



#390 8.6 mm   
Spaccatelli



#399 8.8 mm  
Trifoglio



#402 8 mm   
Gargati Veneti  
[1.5 mm wall thickness]  
[with ridges]



#438 26 mm   
Canestri/Lumache  
[with ridges]



#448 24 mm   
Sunshine



#456 17 mm   
Maccherone Greco

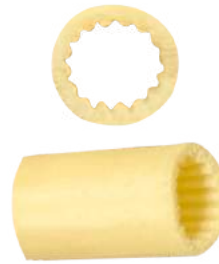

#2020 13 mm   
Inside-Out Rigatoni

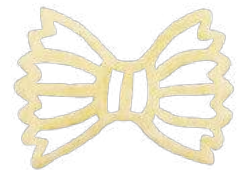

#2023   
Custom Farfalle

## SOME OF OUR FUN SHAPES



#509C   
Star



#509D   
Shooting Star



#513   
Heart



#515   
Tennis Racket



#517   
Mushroom



#529/02   
Bat



#529/04   
Pumpkin



#549   
Pumpkin



#529/06   
Spider



#529/08   
Ghost



#559   
Dollar Sign



#509B   
Tree



#580   
Grapes

# EXTRUDED PASTA SHAPES

## FOR MODELS AEX18 JEMMA

### LASAGNA SHEET DIE



#60s 

Lasagna Sheet Die  
with Adjustable thickness

Dough Width: 6.25"

Adjustable Thickness: 1/32" - 3/16"

Lasagna sheet thickness is adjustable to suit your preference. We recommend around 1/16" thickness for baked lasagna... no pre-cooking needed!

### BUSIATE DIE

#428   
Busiate



Supplied with  
Manual Crank Handle



Optional  
Automatic Crank Attachment



### CUSTOM SHAPES

Contact us for more information.

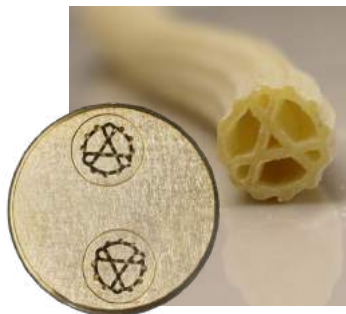
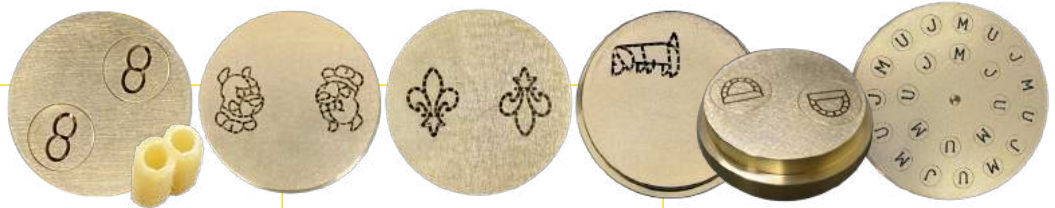

# PASTA CARTS & TRAYS

## STANDARD FEATURES

- APC7 and APC8 ideal for models AEX18 & AEX30 (Standard counter top height)
- Pasta Carts are NSF approved

### APC7 PASTA ON THE MOVE

CARTINA



### APC8 PASTA ON THE MOVE

CATERINA



### APC20 TOWER OF PISA

MARTINA



### APTP PERFORATED PASTA TRAY



### APTS SOLID PASTA TRAY



# PASTA DRYER EXTENDS SHELF LIFE OF PASTA

### ASD20 - LAB ARTISAN SMALL BATCH LAB DRYER

MONICA



## STANDARD FEATURES

- Advanced programmable recipe dryer
- Programmable recipes for different shapes and thicknesses

## TECHNICAL SPECIFICATIONS

Trays	20
Tray Size	31.50"W x 23.75"D
Pasta Per Tray	4 - 5 lbs
Fresh Capacity	80 - 100 lbs
Dry Capacity	60 - 80 lbs/cycle
Power	230V/3/60Hz, 16 Amps
Machine Dimensions	40"W x 41"D x 67"H
Shipping Dimensions	49"W x 51"D x 75"H
Machine Weight	411 lbs
Shipping Weight	700 lbs

### ASD50/75/100/150/200 EXTENDS SHELF LIFE

PICASSO



## STANDARD FEATURES

- Advanced programmable recipe dryer
- Fan controls temperature & humidity, so product dries from the inside out

### TRAY SIZES:

ASD50S  
21.50"W x 23.75"D

ASD50/75/100/150/200  
21.50"W x 23.75"D



TECH SPECS	ASD50S	ASD50	ASD75
Trays	50	50	75
Pasta per Tray	4 - 6 lbs	6 - 8 lbs	6 - 8 lbs
Fresh Capacity	300 lbs	400 lbs	660 lbs
Dry Capacity	240 lbs/cycle	320 lbs/cycle	480 lbs/cycle
Power	208-230V/3/60Hz, 5.5kW	208-230V/3/60Hz, 6.7kW	208-230V/3/60Hz, 8.5kW
Machine Dimensions	71"W x 41"D x 87"H	71"W x 55"D x 87"H	98.5"W x 65"D x 87"H
Shipping Dimensions	73"W x 44"D x 91"H	78"W x 65"D x 99"H	103"W x 70"D x 91"H
Machine Weight	710 lbs	1285 lbs	1390 lbs
Shipping Weight	925 lbs	1510 lbs	1650 lbs

TECH SPECS	ASD100	ASD150	ASD200
Trays	100	150	200
Pasta per Tray	6 - 8 lbs	6 - 8 lbs	6 - 8 lbs
Fresh Capacity	800 lbs	1200 lbs	1600 lbs
Dry Capacity	640 lbs/cycle	960 lbs/cycle	1280 lbs/cycle
Power	208-230V/3/60Hz, 12kW	208-230V/3/60Hz, 18kW	208-230V/3/60Hz, 20kW
Machine Dimensions	98.5"W x 102"D x 87"H	98.5"W x 110"D x 87"H	98.5"W x 134"D x 95"H

## WARRANTY

**One Year:** For more information visit [arcobalenollc.com/warranty.html](http://arcobalenollc.com/warranty.html)



## TRY BEFORE YOU BUY

In an effort to ensure success, we maintain a test kitchen where you can have your very own recipe tested for quality — at NO COST to you! Call for details.



# FRESHLY MILLED FLOUR

## HOW TO DIFFERENTIATE AND BE A LEADER IN FRESH PASTA MAKING

### AFM150

FARM TO TABLE FRESH FLOUR

Make fresh flour right when you need it!

LUNA



#### STANDARD FEATURES

- Ideal for obtaining fresh flour for pasta, pastries, bread and many others
- Adjustable grinder for regulating the flour granular
- Interchangeable sieve screens for different granularity

#### TECHNICAL SPECIFICATIONS

Hourly Production*	Soft White Wheat 75% extract Up to 150 lbs/hr *Production varies by sieve screen
Electrical Power	220/1/60Hz
Machine Dimensions	20"W x 19.25"D x 35.75"H
Shipping Dimensions	24"W x 20"D x 45"H
Machine Weight	140 lbs
Shipping Weight	190 lbs



Fresh Whole Berries from the farm, fresh ground flour with interchange screens for different textures, is filled with delicious flavor, wholesome goodness, and new pastabilities!

Get ready to join the food revolution and discover fresh ground flour. Exceptional flavor-filled flour to make your fresh pasta with outstanding taste and health benefits.

## TYPES OF FLOUR



### SEMOLINA

Semolina flour is a granular flour with a light yellow color. It is produced from durum wheat, which is used almost exclusively for making pasta. It is also high in protein and gluten. When using Semolina flour in an extruder, you will be delighted with superior results!

### DURUM WHEAT

Durum wheat has the ideal properties for making the best pasta. It is high in protein and gluten, which are both necessary for pasta making.

### WHOLE WHEAT

Whole wheat flour is produced from grinding the full wheat berry (kernel). All parts of the wheat berry are used in the flour including the bran, germ and endosperm; which when milled, creates the speckled brown color that is a characteristic of the flour.

### GLUTEN FREE

Gluten is the protein present in wheat flour and it can be challenging to bake without it. Some popular gluten free flours are white rice, buckwheat, millet, masa and chickpea flour.

### DOUBLE ZERO

In Italy, flour is classified as 1, 0, or 00, according to how finely ground the flour is and how much bran and germ have been removed. 00 is the most highly refined flour and is talcum powder soft, yet holds its protein and nutritional value.

**PURPLE BARLEY + EMMERSPELT + FARRO + BUCKWHEAT + RYE + CHICKPEA + RICE FLOUR + MORE!**

# MEET THE ARCOBALENO EXTRUDER FAMIGLIA!

## HOME

### AEX5 HOME MODEL

Up to 5 lbs/hr\*

VITA



## COUNTER TOP

### AEX18 CHEF'S FAVORITE

Up to 15-20 lbs/hr\*

JEMMA



### AEX30 IMPROVING ON THE ORIGINAL

Up to 30 lbs/hr\*

STELLA



## INDUSTRIAL PASTA EXTRUDERS

### AEX50 PUSHING BEYOND EXCELLENCE

Up to 50 lbs/hr\*

ARIA



### AEX90 THE ARTISAN

Up to 90 lbs/hr\*

GIA



### AEX90M THE ARTISAN TWO

Up to 110 lbs/hr\*

GIA-M



### AEX130 IN LOVE WITH PASTA

Up to 130 lbs/hr\*

CHIARA



### AEX130M IN LOVE WITH PASTA

Up to 200 lbs/hr\*

CHIARA-M



### AEX440/440M FACTORY DUTY

Up to 400 lbs/hr\* (AEX440)  
Up to 440 lbs/hr\* (AEX440M)

DANIELLA-M



\*Extruder production varies by pasta shape

THE ONLY FULL-SERVICE PASTA MACHINE MANUFACTURER IN NORTH AMERICA!



**ARCOBALENO LANCASTER HEADQUARTERS**  
WE LOVE VISITORS!



**ARCOBALENO'S ON-LOCATION TEST KITCHEN**  
COME MAKE PASTA WITH US!

#PASTAISFORSHARING



**ARCOBALENO®**  
PASTA EQUIPMENT

*Specifications subject to change without notice. ©2023 Arcobaleno®, LLC*

160 GREENFIELD ROAD | LANCASTER, PA 17601  
ARCOBALENOPASTA.COM | 717.394.1402

 @ARCOBALENOPASTA

RO\_0923